

# HYDRA RAM<sup>®</sup>

ADVANCED DEMOLITION EQUIPMENT



**HSS SERIES**



**11 MODELS SCRAP SHEARS FROM 450 UP TO 20.000 KGS  
FOR EXCAVATORS FROM 3 ~ 280 TONS**









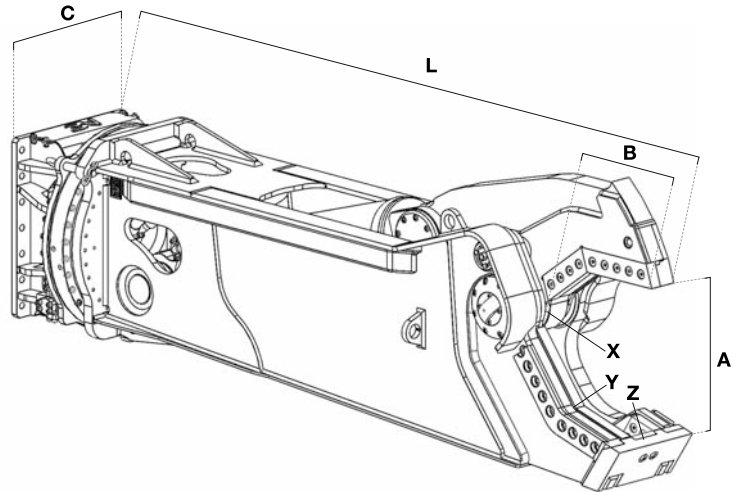













# HYDRA RAM®

ADVANCED DEMOLITION EQUIPMENT

## HSS SERIES



		HSS-5RV	HSS-8RV	HSS-12RV	HSS-18RV	HSS-25RV	HSS-30RV	HSS-40RV	HSS-55RV	HSS-70RV	HSS-90RV	HSS-200RV
 * (1)	t.	2,5 : 4	4 : 7	7 : 10	10 : 16	16 : 20	20 : 25	25 : 30	30 : 40	45 : 55	70 : 90	140 : 190
 ** (1)	t.	5 : 8	8 : 12	12 : 18	18 : 23	23 : 30	30 : 38	40 : 50	55 : 70	75 : 100	120 : 150	200 : 280
 ***	kg.	450	750	1180	1650	2350	2800	3900	5650	7180	9250	19160
A	mm.	340	405	475	535	575	615	680	780	845	920	1180
B	mm.	320	355	385	445	495	545	600	690	710	780	1130
C	mm.	460	460	570	715	715	715	865	1000	1100	1200	1750
L	mm.	1725	2050	2300	2660	2900	3110	3420	3905	4190	4400	5580
	t.	35	65	72	80	140	170	200	215	280	355	480
X	t.	125	210	225	250	460	550	600	700	815	1075	1540
Y	t.	50	90	95	110	210	230	270	290	375	480	690
Z	t.	25	50	55	60	105	125	145	160	205	265	350
	bar	250	310	310	310	340	340	340	340	340	340	340
	l/min.	80 / 150	100 / 150	150 / 250	180 / 250	200 / 300	200 / 300	300 / 400	400 / 500	450 / 600	500 / 800	900 / 1200
												
 max	bar	120	120	140	140	140	140	140	140	140	140	140
 max	l/min.	10	10	10	10	10	10	10	30	30	50	50

(\*) Machinery Class for mounting to main arm  
 (\*\*) Machinery Class for mounting on dipperstick  
 (\*\*\*) The above mentioned weight is without connection plate  
 (1) Recommended excavator / attachment combination

(DEALER)



**HYDRA  RAM®**  
 ADVANCED DEMOLITION EQUIPMENT

**HYDRARAM b.v.**  
 Meander 7  
 NL 9231DB SURHUISTERVEEN  
 The Netherlands

tel. +31 512-365981  
 fax. +31 512-365761  
 www.hydraram.com  
 info@hydraram.com